

Adapter for 2 Circuit Track D-TRACK

art.-no. 172220 / 172221 / 172224



172010/11/14
172020/21/24
172030/31/34

230V
~50/60
Hz

2A
max.

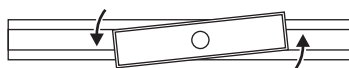
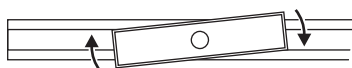
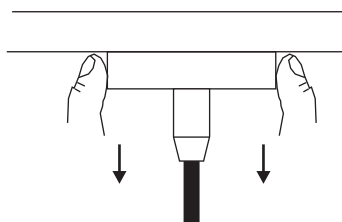
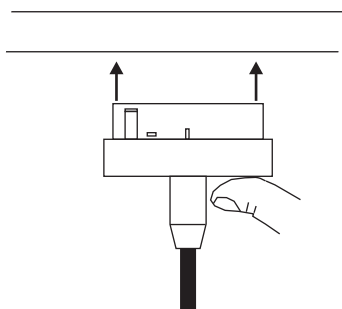
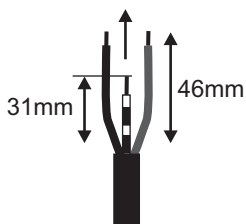
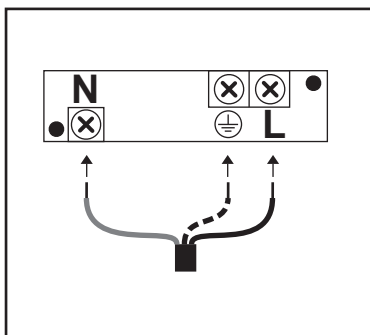
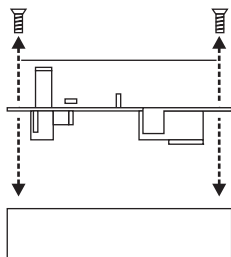
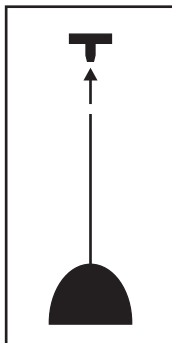
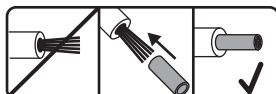

Adapter for 2 Circuit Track D-TRACK

art.-no. 172220 / 172221 / 172224



172010/11/14
172020/21/24
172030/31/34

230V
~50/60
Hz

2A
max.

